

GASKETS

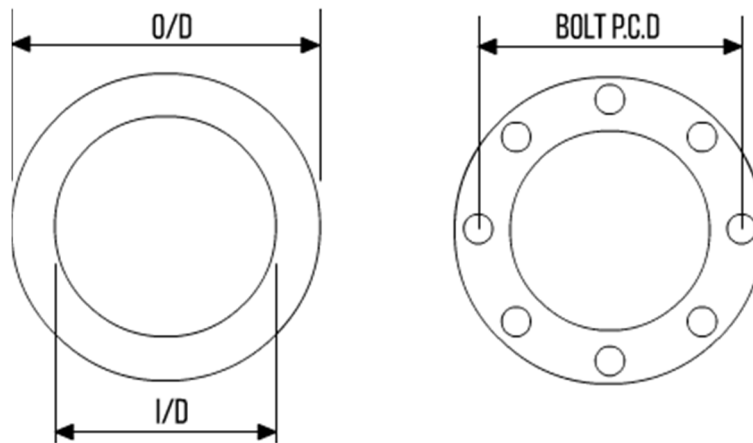

SOFT CUT GASKETS – PN10 DIMENSIONS



NOMINAL BORE	IBC GASKET	FULL FACE GASKET			
	OD x ID	OD x ID	NO. OF HOLES	HOLE DIA.	P.D.C
10	45 x 18	90 x 18	4	14	60
15	50 x 22	95 x 22	4	14	65
20	60 x 28	105 x 28	4	14	75
25	70 x 35	115 x 35	4	14	85
32	82 x 43	140 x 43	4	18	100
40	92 x 49	150 x 49	4	18	110
50	107 x 61	165 x 61	4	18	125
65	127 x 77	185 x 77	8	18	145
80	142 x 90	200 x 90	8	18	160
100	162 x 115	220 x 115	8	18	180
125	192 x 141	250 x 141	8	18	210
150	218 x 169	285 x 169	8	22	240
200	273 x 220	340 x 220	12	22	295
250	328 x 274	395 x 274	12	22	350
300	378 x 325	445 x 325	12	22	400
350	438 x 356	505 x 356	16	22	460
400	489 x 407	565 x 407	16	26	515
450	539 x 458	615 x 458	20	26	565
500	594 x 508	670 x 508	20	26	620
600	695 x 610	780 x 610	20	30	725
700	810 x 712	895 x 712	24	30	840
800	917 x 813	1015 x 813	24	33	950

GASKETS



900	1071 x 915	1115 x 915	28	33	1050
1000	1124 x 1016	1230 x 1016	28	36	1160
1100	1231 x 1120	1340 x 1120	32	39	1270
1200	1341 x 1220	1455 x 1220	32	39	1380
1400	1548 x 1420	1675 x 1420	36	42	1590
1500	1658 x 1520	1785 x 1520	36	42	1700
1600	1772 x 1620	1915 x 1620	40	48	1820
1800	1972 x 1820	2115 x 1820	44	48	2020
2000	2182 x 2020	2325 x 2020	48	48	2230

- All dimensions in millimetres