

GASKETS

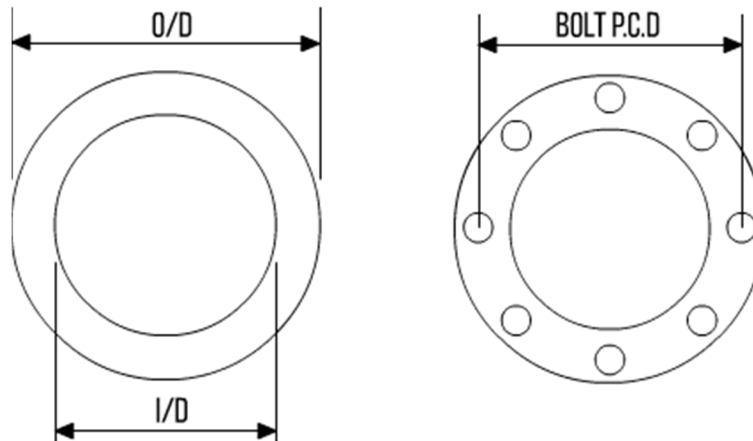

SOFT CUT GASKETS – CLASS 150 DIMENSIONS
ASME B16.20 / ASME B16.47



NOMINAL BORE	IBC GASKET	FULL FACE GASKET			
	OD x ID	OD x ID	NO. OF HOLES	HOLE DIA.	P.D.C
1/2"	48 x 21	89 x 21	4	16	60
3/4"	57 x 27	95 x 27	4	16	70
1"	67 x 33	108 x 33	4	16	79
1.1/4"	76 x 42	117 x 42	4	16	89
1.1/2"	86 x 48	127 x 48	4	16	98
2"	105 x 60	152 x 60	4	19	121
2.1/2"	124 x 73	178 x 73	4	19	140
3"	137 x 89	191 x 89	4	19	152
3 1/2"	162 x 102	216 x 102	8	19	178
4"	175 x 114	229 x 114	8	19	191
5"	197 x 141	254 x 141	8	22	216
6"	222 x 168	279 x 168	8	22	241
8"	279 x 219	343 x 219	8	25	298
10"	340 x 273	406 x 273	12	25	362
12"	410 x 324	483 x 324	12	29	432
14"	451 x 356	533 x 356	12	29	476
16"	514 x 406	597 x 406	16	32	540
18"	549 x 457	635 x 457	16	32	578
20"	606 x 508	699 x 508	20	32	635
24"	718 x 610	813 x 610	20	35	749

- All dimensions in millimetres (unless otherwise shown)
- Above table – Dimensions are in accordance with ASME B16.20
- Series A & B – Dimensions are in accordance with ASME B16.47

GASKETS



NOMINAL BORE SERIES A	IBC GASKET	FULL FACE GASKET			
	OD x ID	OD x ID	NO. OF HOLES	HOLE DIA.	P.D.C
22" (550)	660 x 559	749 x 559	20	35	692
26" (650)	775 x 660	870 x 660	24	35	806
28" (700)	832 x 711	927 x 711	28	35	864
30" (750)	883 x 762	984 x 762	28	35	914
32" (800)	940 x 813	1060 x 813	28	41	978
34" (850)	991 x 864	1111 x 864	32	41	1029
36" (900)	1048 x 914	1168 x 914	32	41	1086
38" (950)	1111 x 965	1238 x 965	32	41	1149
40" (1000)	1162 x 1016	1289 x 1016	36	41	1200
42" (1050)	1219 x 1067	1346 x 1067	36	41	1257
44" (1100)	1276 x 1118	1403 x 1118	40	41	1314
46" (1150)	1327 x 1168	1454 x 1168	40	41	1365
48" (1200)	1384 x 1219	1511 x 1219	44	48	1422
50" (1250)	1435 x 1270	1568 x 1270	44	48	1480
52" (1300)	1492 x 1321	1626 x 1321	44	48	1537
54" (1350)	1549 x 1372	1683 x 1372	44	48	1594
56" (1400)	1607 x 1422	1746 x 1422	48	48	1651
58" (1450)	1664 x 1473	1803 x 1473	48	48	1708
60" (1500)	1715 x 1524	1854 x 1524	52	48	1759

NOMINAL BORE SERIES B	IBC GASKET	FULL FACE GASKET			
	OD x ID	OD x ID	NO. OF HOLES	HOLE DIA.	P.D.C
26" (650)	725 x 660	768 x 660	36	22	745
28" (700)	776 x 711	837 x 711	40	22	795
30" (750)	827 x 762	887 x 762	44	22	846
32" (800)	881 x 813	941 x 813	48	22	900
34" (850)	935 x 864	1005 x 864	40	25	957
36" (900)	987 x 914	1057 x 914	44	25	1010
38" (950)	1045 x 965	1124 x 965	40	29	1070
40" (1000)	1095 x 1016	1175 x 1016	44	29	1121
42" (1050)	1146 x 1067	1226 x 1067	48	29	1172
44" (1100)	1197 x 1118	1276 x 1118	52	29	1222
46" (1150)	1256 x 1168	1341 x 1168	40	32	1284
48" (1200)	1307 x 1219	1392 x 1219	44	32	1335
50" (1250)	1357 x 1270	1443 x 1270	48	32	1386
52" (1300)	1408 x 1321	1494 x 1321	52	32	1437
54" (1350)	1464 x 1372	1549 x 1372	56	32	1492
56" (1400)	1514 x 1422	1600 x 1422	60	32	1543
58" (1450)	1580 x 1473	1675 x 1473	48	35	1611
60" (1500)	1630 x 1524	1726 x 1524	52	35	1662