

GASKETS

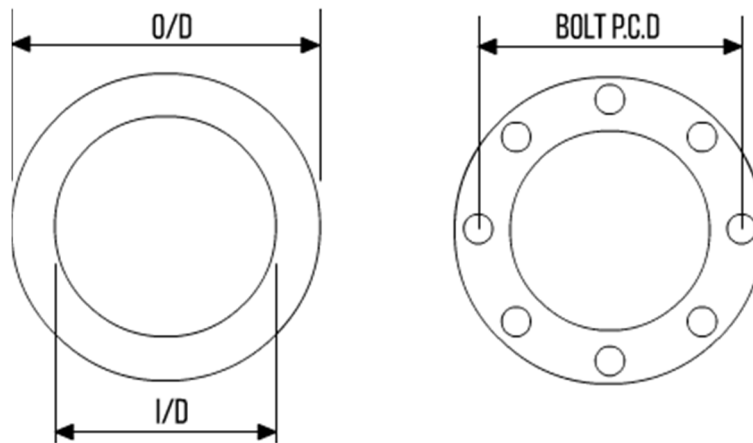

SOFT CUT GASKETS – PN16 DIMENSIONS



NOMINAL BORE	IBC GASKET	FULL FACE GASKET			
	OD x ID	OD x ID	NO. OF HOLES	HOLE DIA.	P.D.C
10	45 x 18	90 x 18	4	14	60
15	50 x 22	95 x 22	4	14	65
20	60 x 28	105 x 28	4	14	75
25	70 x 35	115 x 35	4	14	85
32	82 x 43	140 x 43	4	18	100
40	92 x 49	150 x 49	4	18	110
50	107 x 61	165 x 61	4	18	125
65	127 x 77	185 x 77	8	18	145
80	142 x 90	200 x 90	8	18	160
100	162 x 115	220 x 115	8	18	180
125	192 x 141	250 x 141	8	18	210
150	218 x 169	285 x 169	12	22	240
200	273 x 220	340 x 220	12	22	295
250	329 x 274	405 x 274	12	26	355
300	384 x 325	460 x 325	16	26	410
350	444 x 356	520 x 356	16	26	470
400	495 x 407	580 x 407	16	30	525
450	555 x 458	640 x 458	20	30	585
500	617 x 508	715 x 508	20	33	650
600	734 x 610	840 x 610	20	36	770
700	804 x 712	910 x 712	24	36	840
800	911 x 813	1025 x 813	24	39	950

GASKETS



900	1011 x 915	1125 x 915	28	39	1050
1000	1128 x 1120	1255 x 1016	28	42	1170
1100	1228 x 1120	1355 x 1120	32	42	1270
1200	1342 x 1420	1485 x 1220	32	48	1390
1400	1542 x 1420	1685 x 1420	36	48	1590
1500	1654 x 1520	1820 x 1520	36	56	1700
1600	1764 x 1620	1930 x 1620	40	56	1820
1800	1964 x 1820	2130 x 1820	44	56	2020
2000	2168 x 2020	2345 x 2020	48	62	2230

- All dimensions in millimetres